



LED TUBES & FIXTURES WITH LED

V-TAC's extensive range of efficient tubes & fixtures boasts of premium quality LED provided by Samsung, a staggering lifespan of up to 30,000 hours, unbreakable body built with the most durable materials in the market, and a wide range of lengths and sizes for different applications.

More innovative additions in this range include

- 1) TP(a) rated fixtures compatible with emergency packs & microwave sensors
- 2) Batten Fittings with CCT-changing Switch
- 3) Linkable T5 Batten Fittings, and more.

APPLICATION

Used for general purpose lighting in residences, commercial establishments, supermarkets, and offices

V-TAC[®]
INNOVATIVE LED LIGHTING



KEY FEATURES

- LED provided by Samsung
- Lasts up to 30,000 hrs
- Built with strong, durable materials
- TP(a) Rated fittings for select models
- Programmable DIP Switch Driver for select models
- Emergency Pack & Sensor Compatibility
- Linkable/Continuous T5 fittings
- CCT Changing Switch for select models

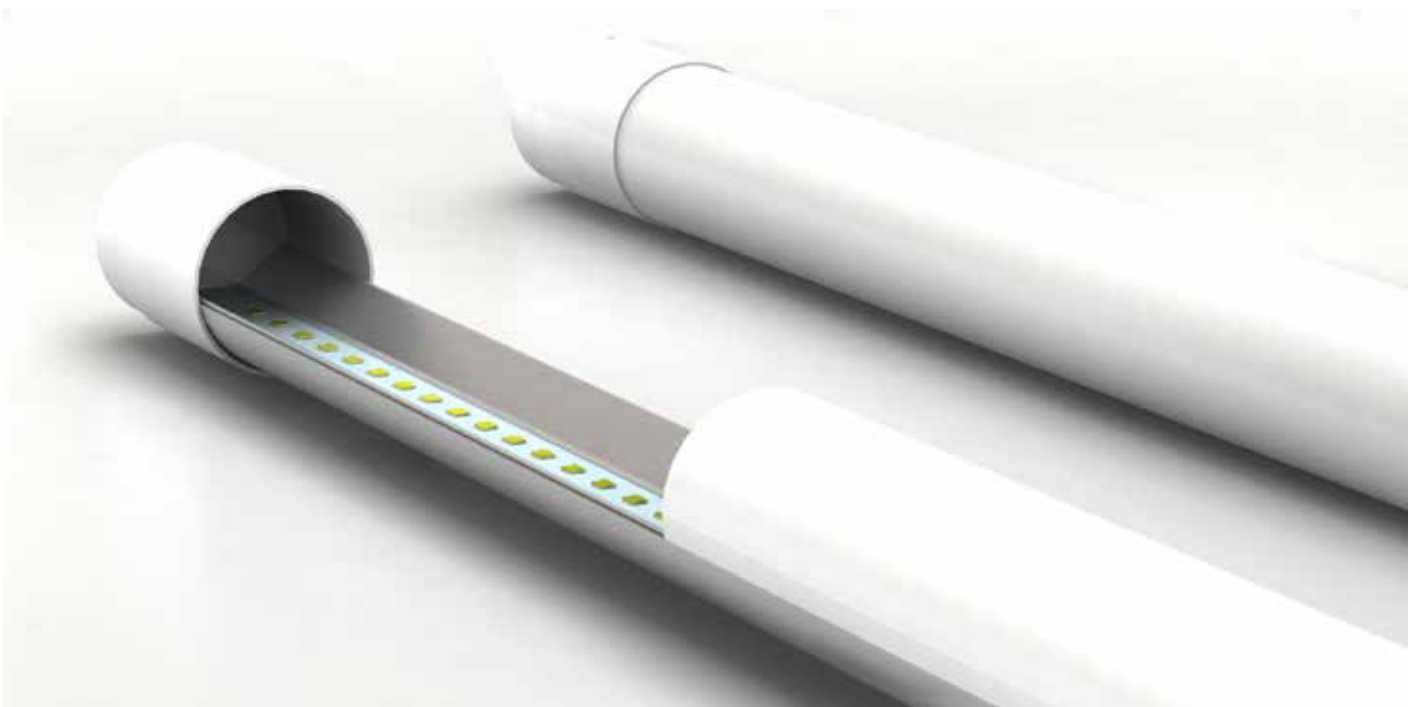



LED TUBES

G13-T8 -Nano Plastic Tube

This modern range of high-lumen LED tubes with Samsung LED chip are the perfect retrofit for fluorescent fixtures. Complete with a series of pop kits (batten fittings inclusive of tubes), these sets of tubes are available in standard lengths for general purpose lighting in residences, commercial establishments, supermarkets, and offices.

- **SMD LED Type**
- **30,000 hrs Lifespan**
- **160° Beam Angle**
- **15000 On/Off**
- **AC:220-240V,50Hz**
- **>80 CRI**
- **>0.5 PF**
- **Nano Plastic Body**
- **<0.5 s Instant Start**

5 YEAR
WARRANTY*

MODEL	WATTS	EQ.WATTS	LUMENS	WEIGHT-KG	BOX QTY.
VT-062	10w	18w	1100	0.1264	25 pcs

SKU: 686 | 4000K DAY WHITE
SKU: 687 | 6400K WHITE

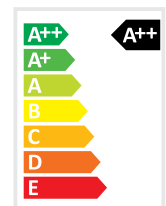
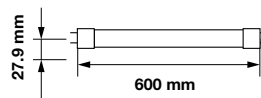

MODEL	WATTS	EQ.WATTS	LUMENS	WEIGHT-KG	BOX QTY.
VT-122	18w	45w	2250	0.1904	25 pcs

SKU: 688 | 3000K WARM WHITE
SKU: 672 | 4000K DAY WHITE
SKU: 673 | 6400K WHITE

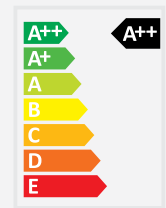
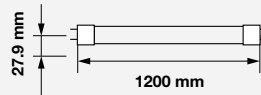

MODEL	WATTS	EQ.WATTS	LUMENS	WEIGHT-KG	BOX QTY.
VT-152	22w	75w	3000	0.2572	25 pcs

SKU: 674 | 4000K DAY WHITE
SKU: 675 | 6400K WHITE

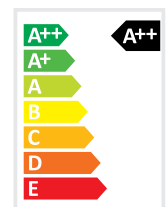
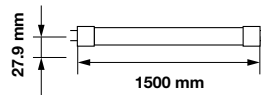

MODEL WATTS EQ.WATTS LUMENS WEIGHT-KG BOX QTY.

VT-061 **10w** **18w** **850** **0.1264** **25 pcs**

SKU: 650 | 3000K WARM WHITE
 SKU: 651 | 4000K DAY WHITE
 SKU: 652 | 6400K WHITE

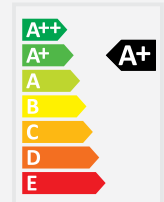
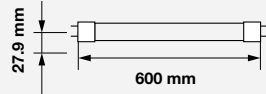

MODEL WATTS EQ.WATTS LUMENS WEIGHT-KG BOX QTY.

VT-121 **18w** **36w** **1700** **0.1904** **25 pcs**

SKU: 653 | 3000K WARM WHITE
 SKU: 654 | 4000K DAY WHITE
 SKU: 655 | 6400K WHITE

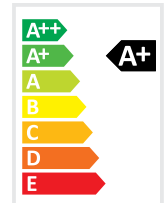
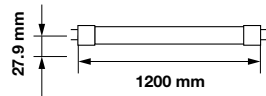

MODEL WATTS EQ.WATTS LUMENS WEIGHT-KG BOX QTY.

VT-151 **22w** **58w** **2000** **0.2572** **25 pcs**

SKU: 656 | 3000K WARM WHITE
 SKU: 657 | 4000K DAY WHITE
 SKU: 658 | 6400K WHITE

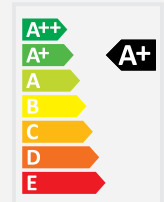
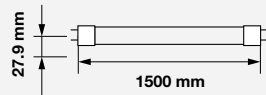

LED BATTEN FITTINGS

Single and Double Batten Fitting

This modern range of batten fittings offer durability and can house one to two LED tubes. These luminaires are available in standard lengths for general purpose lighting in residences, commercial establishments, supermarkets, and offices.

- **SMD LED Type**
- **30,000 hrs Lifespan**
- **160° Beam Angle**
- **AC:220-240V,50Hz**
- **CRI: >80**
- **Nano Plastic Body**

5 YEAR
WARRANTY*



MODEL	WATTS	LUMENS	ON/OFF	PF	BOX QTY.
VT-12026	18w	1700	15000	>0.5	10 pcs

SKU: 6442 | 4000K DAY WHITE
SKU: 6443 | 6400K WHITE



MODEL	WATTS	LUMENS	ON/OFF	PF	BOX QTY.
VT-15023	22w	2000	15000	>0.5	10 pcs

SKU: 6438 | 4000K DAY WHITE
SKU: 6439 | 6400K WHITE





MODEL	WATTS	LUMENS	ON/OFF	PF	BOX QTY.
VT-12027	36w	3400	15000	>0.5	10 pcs

SKU: 6444 | 4000K DAY WHITE
 SKU: 6445 | 6400K WHITE



MODEL	WATTS	LUMENS	ON/OFF	PF	BOX QTY.
VT-15024	44w	4000	15000	>0.5	10 pcs

SKU: 6440 | 4000K DAY WHITE
 SKU: 6441 | 6400K WHITE





FIXTURES WITH LED

LED Prismatic Fittings



Quick Connector

The reliable 10w to 60w range of efficient LED prismatic fittings from V-TAC all have a high-lumen rating of 120 lm/w and are equipped with quick connectors to lessen set-up time during installation. Available in 3000K, 4000K, and 6400K color temperatures, these durable fittings are ideal for any indoor lighting use

- **SMD LED Type**
- **30,000 hrs Lifespan**
- **110° Beam Angle**
- **15000 On/Off**
- **AC:220-240V,50Hz**
- **CRI: >80**
- **>0.9 PF**
- **Plastic Body**
- **<0.5 s Instant Start**

5 YEAR
WARRANTY*

MODEL	WATTS	LUMENS	WEIGHT-KG	BOX QTY.
VT-8-10	10w	1200	0.26	10 pcs

SKU: 659 | 3000K WARM WHITE
 SKU: 660 | 4000K DAY WHITE
 SKU: 661 | 6400K WHITE

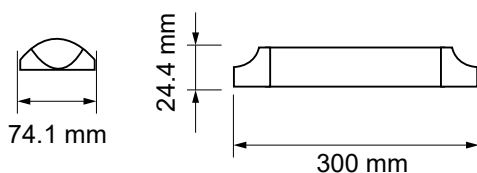

MODEL	WATTS	LUMENS	WEIGHT-KG	BOX QTY.
VT-8-20	20w	2400	0.42	10 pcs

SKU: 662 | 3000K WARM WHITE
 SKU: 663 | 4000K DAY WHITE
 SKU: 664 | 6400K WHITE

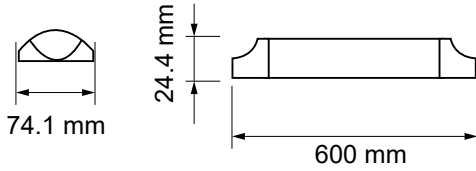

MODEL	WATTS	LUMENS	WEIGHT-KG	BOX QTY.
VT-8-40	40w	4800	0.84	10 pcs

SKU: 665 | 3000K WARM WHITE
 SKU: 666 | 4000K DAY WHITE
 SKU: 667 | 6400K WHITE

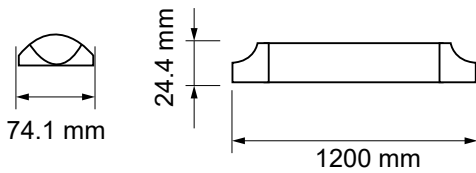

MODEL	WATTS	LUMENS	WEIGHT-KG	BOX QTY.
VT-8-50	50w	6000	1.00	10 pcs

SKU: 668 | 4000K DAY WHITE
 SKU: 669 | 6400K WHITE

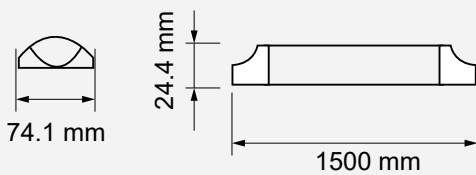

MODEL	WATTS	LUMENS	WEIGHT-KG	BOX QTY.
VT-9-60	60w	7200	1.20	10 pcs

SKU: 670 | 4000K DAY WHITE
 SKU: 671 | 6400K WHITE

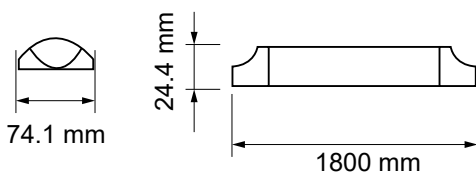



FIXTURES WITH LED

LED Batten Fitting



V-TAC's all new range of LED Batten Fittings designed with LED chip by Samsung deliver high performance light output of 120 lumens/watt. These fittings are built strong using the materials Iron + Polycarbonate and are also TP(a) rated to meet the fire safety standards. Optional microwave sensor specially designed for LED Batten Fittings is also available.

- **TP(A) Rated**
- **30,000 Life Hours**
- **CRI - >80**
- **PF - 0.9**
- **On/Off Cycle - >15000 time**
- **Input Voltage - AC:220-240V**
- **Programmable DIP Switch Driver(Applicable for 60W and 80W only)**

5 YEAR
WARRANTY*

TP(a)
Polycarbonate



Compatible Emergency Pack



Sensor Compatible

MODEL	WATTS	LUMENS	WEIGHT-KG	BOX QTY.
VT-8-42	40w	4800	1.40	10 pcs

SKU: 755 | 4000K DAY WHITE

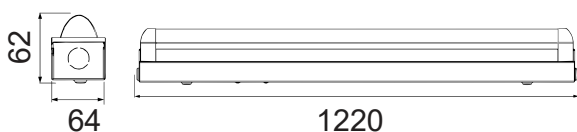



MODEL	WATTS	LUMENS	WEIGHT-KG	BOX QTY.
VT-8-62	60w	6900	1.72	10 pcs

SKU: 756 | 4000K DAY WHITE

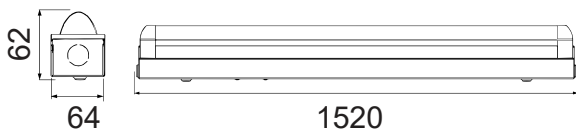

MODEL	WATTS	LUMENS	WEIGHT-KG	BOX QTY.
VT-8-80	80w	8600	2.07	10 pcs

SKU: 757 | 4000K DAY WHITE

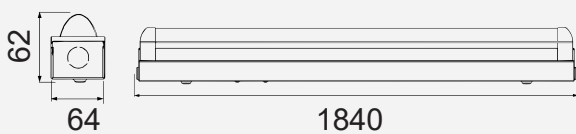

Emergency Pack (Optional)

m-pack SKU: 758 Compatible with Batten

Charging time::

≥24 HOURS

Charge current:

200 MA

Working time :

3 HOURS



Microwave Sensor (Optional)

VT-8-6 SKU: 759 Compatible with Batten

Detection area:

4M (@3M MOUNTING HEIGHT)

Detection angle:

150°(WALL) 360°(CEILING)

Hold time:

5S / 30S / 90S / 3MIN / 30MIN





LINKABLE
UP TO 100 WATTS TOGETHER

FIXTURES WITH LED

T5 Batten Fitting

5 YEAR
WARRANTY*

The new T5 Batten Fittings retain the premium qualities of V-TAC's fixtures with LED. Each fitting is fully compatible & linkable; multiple batten fittings can be connected with each other, making it an efficient alternative lighting fixture for both small and big indoor spaces.

- **30,000 Life Hours**
- **PF - 0.9**
- **On/Off Cycle - >15000 time**
- **Input Voltage - AC:220-240V**
- **CRI - >80**
- **LED Provided by Samsung**

MODEL	WATTS	LUMENS	WEIGHT-KG	BOX QTY.
VT-035	4w	360	0.065	25 pcs

SKU: 689 | 3000K WARM WHITE
 SKU: 690 | 4000K DAY WHITE
 SKU: 691 | 6400K WHITE

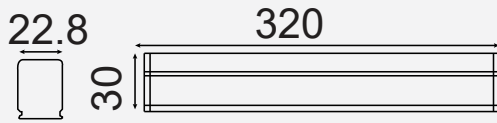

MODEL	WATTS	LUMENS	WEIGHT-KG	BOX QTY.
VT-065	7w	630	0.112	25 pcs

SKU: 692 | 3000K WARM WHITE
 SKU: 693 | 4000K DAY WHITE
 SKU: 694 | 6400K WHITE

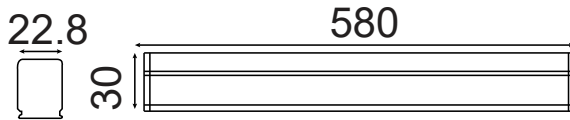

MODEL	WATTS	LUMENS	WEIGHT-KG	BOX QTY.
VT-125	16w	1440	0.16	25 pcs

SKU: 695 | 3000K WARM WHITE
 SKU: 696 | 4000K DAY WHITE
 SKU: 697 | 6400K WHITE

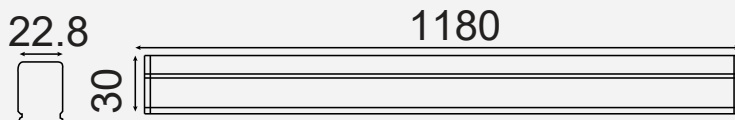



EASY ACCESS FOR
COLOR CHANGING
WITH BUTTON



CCT Changeable



FLICKER FREE

FIXTURES WITH LED

LED Batten Fitting

5 YEAR
WARRANTY*

The new Batten Fittings series from V-TAC boasts of its colour tuning feature with an easy-to-access, built-in switch — enabling users to gradually customise the light from a warm 3000-kelvin white light up to the standard 6400-kelvin white. Choose and switch to your preferred colour temperature anytime.

- **PC+Aluminium+Steel**
- **30,000 Life Hours**
- **CRI - >80**
- **Flicker Free**
- **PF - 0.9**
- **On/Off Cycle - >20000 time**
- **Input Voltage - AC:220-240V,50Hz**

MODEL	WATTS	LUMENS	WEIGHT-KG	BOX QTY.
VT-8-43	40w	4000	1.68	10 pcs

SKU: 517 | 3IN1

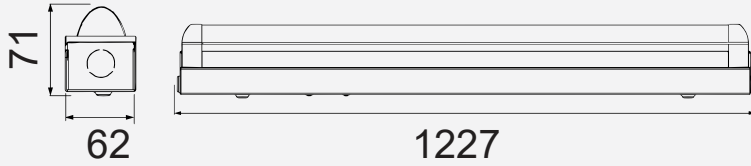

MODEL	WATTS	LUMENS	WEIGHT-KG	BOX QTY.
VT-8-53	50w	5000	2.06	10 pcs

SKU: 518 | 3IN1

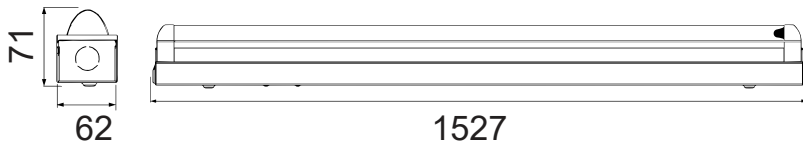

MODEL	WATTS	LUMENS	WEIGHT-KG	BOX QTY.
VT-8-63	60w	6000	2.42	10 pcs

SKU: 519 | 3IN1





FIXTURES WITH LED

LED Batten Fitting



V-TAC's all new range of LED Batten fittings designed with LED chip by Samsung deliver high performance light output of 120 lumens/watt. These fittings are built strong using the materials Iron + Polycarbonate and are also TP(a) rated to meet the fire safety standards. Optional emergency pack and microwave sensor specially designed for LED Batten are also available.

- **TP(A) Rated**
- **30,000 Life Hours**
- **CRI - >80**
- **PF - 0.9**
- **On/Off Cycle - >15000 time**
- **Input Voltage - AC:220-240V**
- **Programmable DIP Switch Driver(Applicable for 60W only)**

5 YEAR
WARRANTY*

TP(a)
Polycarbonate



Sensor Compatible

MODEL	WATTS	LUMENS	WEIGHT-KG	BOX QTY.
VT-8-41	40w	4800	2.90	4 pcs

SKU: 753 | 4000K DAY WHITE

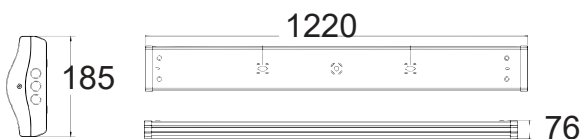

4
FEET

120
LM/WATT

MODEL	WATTS	LUMENS	WEIGHT-KG	BOX QTY.
VT-8-61	60w	7200	3.65	4 pcs

SKU: 754 | 4000K DAY WHITE

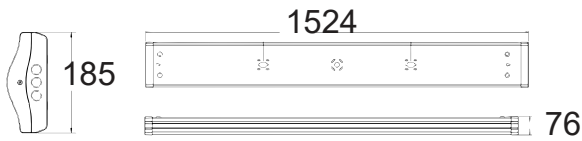

Microwave Sensor (Optional)

VT-8-6 SKU: 759 Compatible with Batten

Detection area:

4M (@3M MOUNTING HEIGHT)

Detection angle:

150°(WALL) 360°(CEILING)

Hold time:

5S / 30S / 90S / 3MIN / 30MIN





FIXTURES WITH LED

LED Waterproof Fittings

With its IP65 rating and tough aluminum exterior, the new LED Tri-Proof Fittings are the optimal choice for a strong and durable fitting for indoor and outdoor lighting. Available in 4ft, 5ft, and 6ft, these high-lumen tri-proof fittings are ideal for illuminating open spaces that are frequently exposed to dust and moisture.

- **SMD LED Type**
- **20,000 - 30,000 hrs Lifespan**
- **110° Beam Angle**
- **IP65 Rating**
- **AC:220-240V,50Hz**
- **CRI: >80**
- **PF: >0.9**

5 YEAR
WARRANTY*

MODEL	WATTS	LUMENS	ON/OFF	BODY TYPE	PF	WEIGHT-KG	BOX QTY.
VT-180	60w	5400	15000	Plastic	>0.9	1.30	9 pcs

SKU: 680 | 4000K DAY WHITE
SKU: 681 | 6400K WHITE

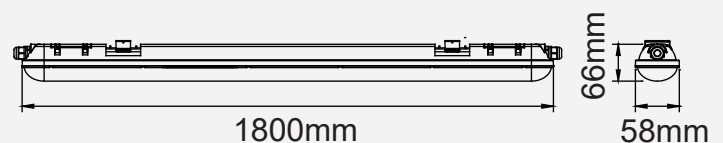

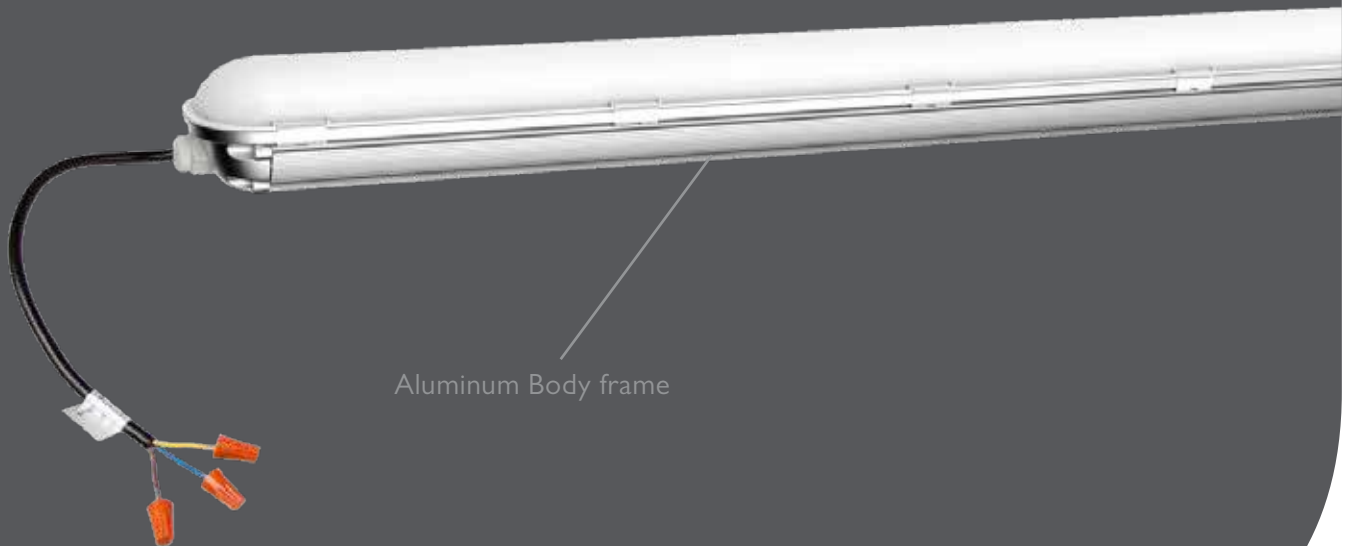

Aluminum Body frame

MODEL	WATTS	LUMENS	ON/OFF	BODY TYPE	PF	WEIGHT-KG	BOX QTY.
VT-160	60w	7200	15000	Plastic+Aluminium	>0.9	2.10	9 pcs

SKU: 678 | 4000K DAY WHITE
 SKU: 679 | 6400K WHITE



FEET



RATING



LM/WATT

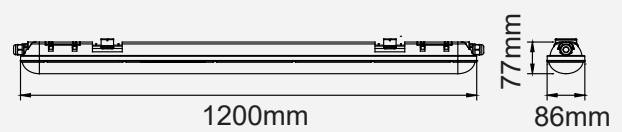

MODEL	WATTS	LUMENS	ON/OFF	BODY TYPE	PF	WEIGHT-KG	BOX QTY.
VT-170	70w	8400	15000	Plastic+Aluminium	>0.9	2.67	9 pcs

SKU: 676 | 4000K DAY WHITE
 SKU: 677 | 6400K WHITE



FEET



RATING



LM/WATT

